

Water Specialist EE Control Valve Programming and Cover Drawing Manual

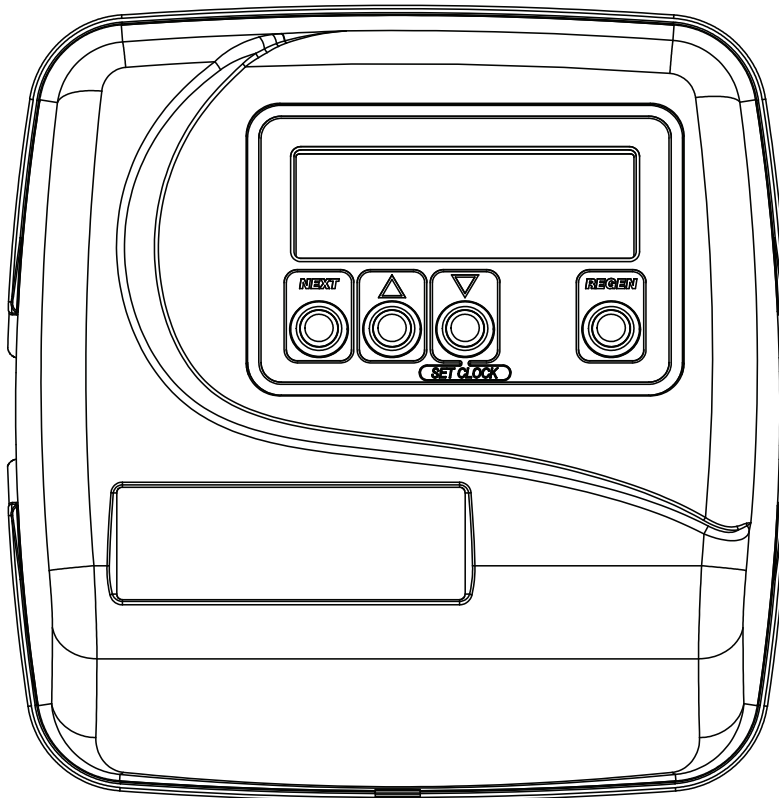

Table of Contents

EE Front Cover and Drive Assembly.....	4
Regeneration and Error Screens, Button Operations and Functions.....	5
User Displays.....	6
Configuration Settings.....	7
OEM Softener System Setup.....	11
Setting Options Table.....	14
OEM Filter System Setup.....	15
Installer Display Settings.....	17
Diagnostics.....	18

EE Front Cover and Drive Assembly

Drawing No.	Order No.	Description	Quantity
1	V3175EE-01	WS1EE FRONT COVER ASSEMBLY	1
2	V3107-01	WS1 MOTOR	1
3	V3106-01	WS1 DRIVE BRACKET & SPRING CLIP	1
4	V3408EE-04BOARD	WS1THRU/2 EE PCB 5 DIGIT REPL	1
5	V3110	WS1 DRIVE GEAR 12X36	3
6	V3109	WS1 DRIVE GEAR COVER	1
Not Shown	V3186	WS1 AC ADAPTER 120V-12V	1
	V3186-01	WS1 AC ADAPTER CORD ONLY	
Not Shown	V3178	WS1 Drive Back Plate	1

Refer to Control Valve Service Manual for other drawings and part numbers.

AC Adapter	U.S.	International
Supply Voltage	120 V AC	230V AC
Supply Frequency	60 Hz	50 Hz
Output Voltage	12 V AC	12 V AC
Output Current	500 mA	500 mA

Relay Specifications: 12V DC Relay with a coil resistance not less than 80 ohms. If mounting relay under the cover check for proper mounting dimensions on the backplate.

Wiring for Correct On/Off Operation	
PC Board Relay Terminal Block	Relay
RLY 1	Coil -
+ COM	Coil +

When replacing the battery, align positives and push down to fully seat.

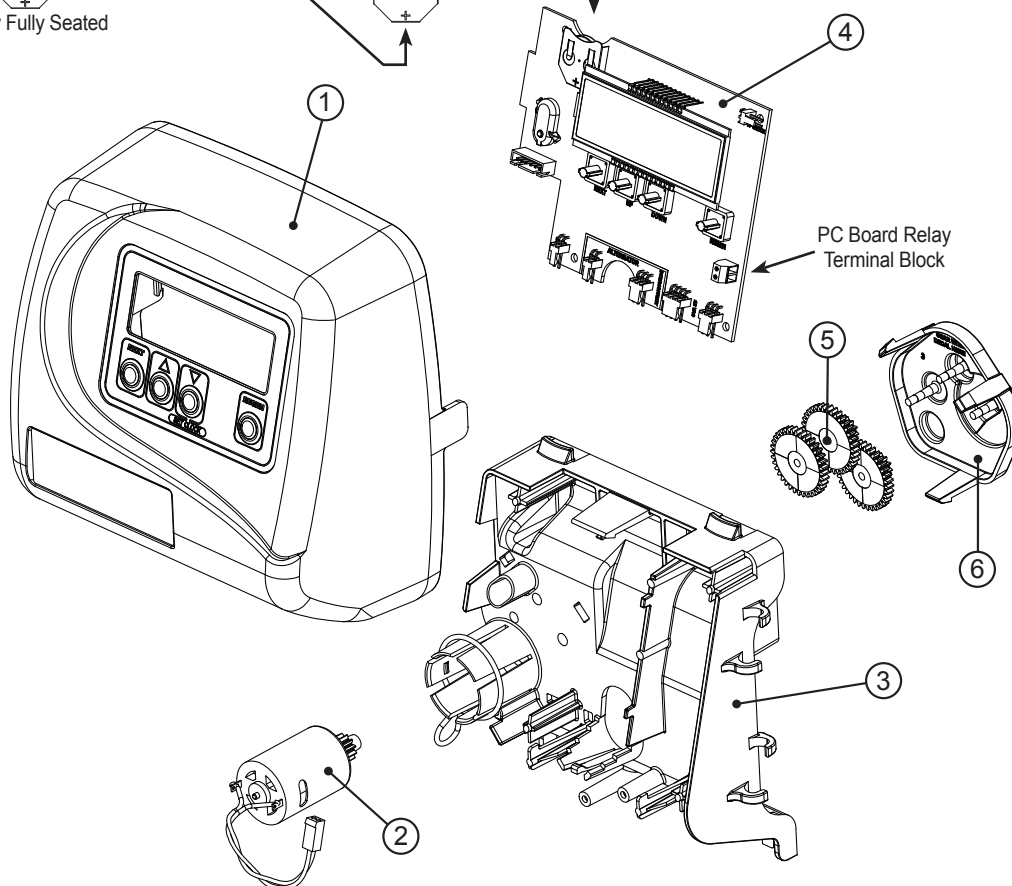
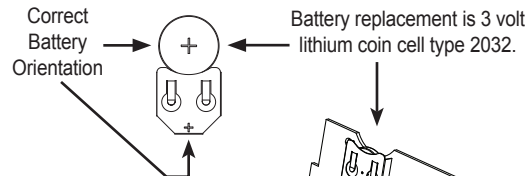
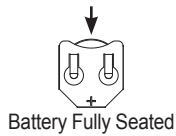

Regeneration and Error Screens



Regen Screen

Displays the time remaining in the current cycle. Pressing REGEN advances to the next cycle.



Error Screen

Alternated flashing Err and error code every 3 seconds. Clear by disconnecting the power supply at the PC board and reconnecting, or press NEXT and REGEN simultaneously for 3 seconds.



In Alternator Systems when a unit is waiting to initiate the first cycle step of regeneration, “REGEN Pndg” is displayed.



“STbY” is displayed in Alternator Systems when a valve is in Standby state.



“REGEN Pndg RINSE FILL” is displayed whenever a zero-capacity tank has transferred to an off-line state and is currently waiting to initiate the second portion of a regeneration cycle. Viewed only when Delayed Rinse and Fill is set to ON.

Button Operation and Function



Scrolls to the next display.

Pressing once and releasing will schedule a regeneration at the preset delayed regeneration time.



Pressing again and releasing will cancel the regeneration.

Pressing and holding for 3 seconds will initiate an immediate regeneration

Pressing while in regeneration will advance to the next cycle.

Pressing in the program levels will go backwards to the previous screen



Changes variable being displayed.



Key sequence to lock and unlock program settings.

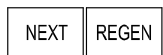

Holding for 3 seconds initiates a control reset. The software version is displayed and the piston returns to the home/service position, resynchronizing the valve.



Used with valve type 1.0Γ, holding for at least 3 seconds causes a switch in the tank in Service without cycling the regeneration valve. After tank switch, days remaining and capacity remaining status is retained for each tank until the next regeneration.

Regeneration Cycles and Times

Cycle	Range		
	Softening	Filtering Regen	Filtering Backwash
Backwash	1-120 minutes	1-120 minutes	1-120 min.
Regenerant Draw/Slow Rinse (UP or DN)	1-180 minutes	1-180 minutes	NA
Fast Rinse	1-120 minutes	1-120 minutes	1-120 min.
Regenerant Refill	0.1-200.0 lbs.	1-99.0 GAL	NA
Regenerant Refill 2.0 or 1.5 set to MIN (softening only)	0.1-99.0 minutes	0.1-99.0 minutes	NA
Service	1-480 minutes	NA	NA

If 1.5 or 2.0 is selected in Step 2CS, cycles can be set to “oFF”.

The user can initiate manual regeneration. The user has the option to request the manual regeneration at the delayed regeneration time or to have the regeneration occur immediately:

1. Pressing and releasing the REGEN button. “REGEN TODAY” will flash on the display and the regeneration will occur at the delayed regeneration time. The user can cancel the request by pressing and releasing the REGEN button.
2. Pressing and holding the REGEN button for approximately 3 seconds will immediately start the regeneration. The user cannot cancel this request, except by resetting the control by pressing NEXT and REGEN simultaneously for 3 seconds.

User Displays

General Operation

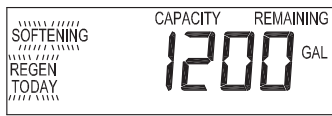

When the system is operating, one of five displays may be shown. Pressing NEXT will alternate between the displays shown below.

User 1

Typical user display. Shows volume remaining to regeneration. This screen will not be viewed if the control is set for time-clock operation.

User 2

Displays number of days to next regeneration.

User 3

Flow Rate.

Displays present flow rate.

Not viewed (along with SOFTENING or FILTERING Icon) if ALT A or ALT b is set in CONFIGURATION 4 and the valve is currently in Standby. When 1.0Γ is set in CONFIGURATION 1, the display will indicate the tank currently in Service (“A” or “b”) in the leftmost digit.

User 4

Displays total volume in gallons since last reset. If a meter is not used this display will be shown but 0 will be displayed.

PRESS ▼ FOR 3 SECONDS TO RESET TO 0.

User 5

Shows current time.

Setting Time of Day

Push NEXT until time of day screen is displayed. Press and hold ▼ until SET TIME is displayed and the hour flashes once. Press ▲ or ▼ until the correct hour is displayed.

Then press NEXT. The minutes will flash. Press ▲ or ▼ until the correct minute is displayed.

Press NEXT to return to the User Displays. Time of day should only need to be set after power outages lasting more than 8 hours, if the battery has been depleted and a power outage occurs, or when daylight saving time begins or ends. If a power outage lasting more than 8 hours occurs, the time of day will flash on and off which indicates the time of day should be reset. If a power outage lasts less than 8 hours and the time of day flashes on and off, the time of day should be reset and the battery replaced.

Configuration Settings

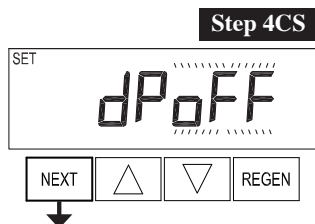
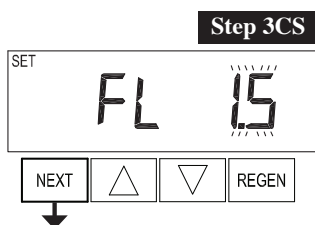
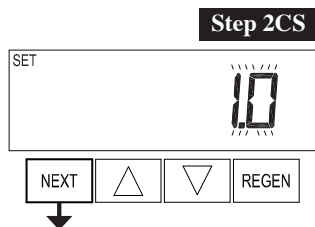
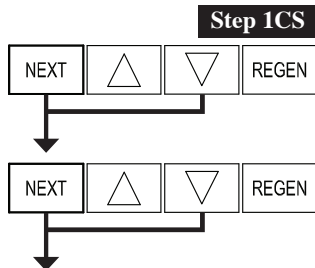

Step 1CS – Press NEXT and ▼ simultaneously for 5 seconds and release. Press NEXT and ▼ simultaneously for 5 seconds and release. If the screen in Step 2CS does not appear, the lock on the valve is activated. To unlock, press ▼, NEXT, ▲ and REGEN in sequence, then press NEXT and ▼ simultaneously for 5 seconds and release. Press NEXT and ▼ simultaneously for 5 seconds and release.

Step 2CS – Use ▲ or ▼ to select 1.0 for 1” valve, 1.25 for 1.25” valve, 1.5 for 1.5” valve, 2.0 for 2” valve or 1.0Γ for twin valve. If 1.0, 1.25 or 1.0Γ are selected, press NEXT to go to Step 4CS. If 1.5 or 2.0 are selected, press NEXT to go to Step 3CS. Press REGEN to exit Configuration Settings.

Step 3CS – Use ▲ or ▼ to select meter size. Settings available are 1.5, 2.0, 3.0, 1.0r (1.0 Remote Meter) or PUL (Variable Meter Calibration.) Variable meter pulses of 0.1-150.0 PPG can be selected. Press NEXT to go to Step 4CS. Press REGEN to return to previous step.

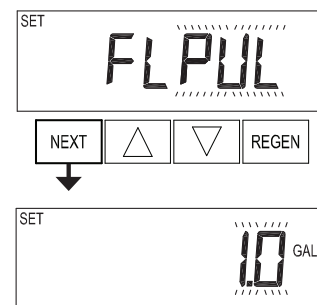

Step 4CS – Selecting the use of an outside signal to initiate a regeneration: Selection only matters if a connection is made to the two pin connector labeled DP SWITCH located on the printed circuit board. Following is an explanation of the options:

oFF - feature not used

NOTE: In a twin alternating system each control must have a separate dP signal or dP switch. One dP signal or one dP switch cannot be used for both controls.

on0 – If the dP switch is closed for an accumulative time of 2 minutes a regeneration will be signaled to the unit. In a twin alternating system the MAV will transition first to switch units so that the signaled unit can start regeneration. After the MAV has fully transitioned, the regeneration begins immediately. Note: For WS1 – WS1.5 control valves programmed for twin alternating: if the dP function “on0” is set, the Delayed Rinse and Fill feature is not available.

dEL – If the dP switch is closed for an accumulative time of 2 minutes a regeneration will occur at the scheduled delayed regeneration time. In a twin alternating system once the dP switch is triggered the PC Board will display “REGEN TODAY” and when the delayed regen time comes the control will switch tanks and the triggered unit will then go into regeneration. Note: For WS1 – WS1.5 control valves programmed for twin alternating: if the dP function “dEL” is set, the Delayed Rinse and Fill feature is not available.

HoLd – If the dP switch is closed a regeneration will be prevented from occurring while there is switch closure. In a twin alternating system the regeneration of a unit can be prevented upon switch closure. If the unit depletes the capacity down to zero, it will not be allowed to switch tanks to regenerate until the switch is open. Note: For WS1 – WS1.5 control valves programmed for twin alternating the Delayed Rinse and Fill feature can be set.

Press NEXT to go to Step 5CS. Press REGEN to return to previous step.

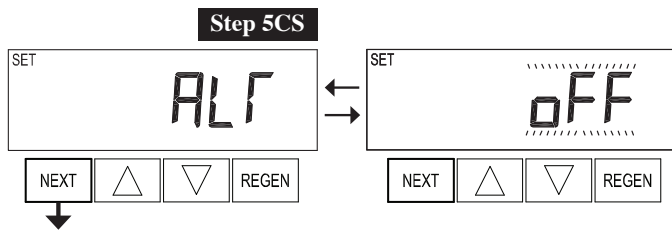

Step 5CS – This display will not appear if 1.0Γ was selected in Step 2CS. Allows selection of one of the following using ▲ or ▼:

- the Control Valve to have no hard water bypass;
- the Control Valve to act as an alternator;
- the Control Valve to have a separate source during the regeneration cycle; or
- the Control Valve to operate with the System Controller.

Select OFF when none of these features are used.

Only use Clack No Hard Water Bypass Valves or Clack Motorized Alternating Valves (MAV) with these selections. Clack No Hard Water Bypass Valves (1” or 1.25” V3070FF or V3070FM) are not designed to be used with the alternator or separate source functions.

Configuring the Control Valve for No Hard Water Bypass Operation:

Select nHbP for control operation. For no hard water bypass operation the three wire communication cable is not used.



Selection requires that a connection to MAV or a Clack No Hard Water Bypass Valve is made to the two pin connector labeled MAV located on the printed circuit board. If using a MAV, the A port of the MAV must be plugged and the valve outlet connected to the B port. When set to nHbP the MAV will be driven closed before the first regeneration cycle that is not FILL or SOFTENING or FILTERING, and be driven open after the last regeneration cycle that is not FILL.

NOTE: If the control valve enters into an error state during regeneration mode, the no hard water bypass valve will return to the open Position, if not already there.

Configuring the Control Valve for Separate Source Operation:

Select SEPS for control operation. For separate source operation the three wire communication cable is not used.



Selection requires that a connection to a Clack Motorized Alternator Valve (MAV) is made to the two pin connector labeled MAV located on the printed circuit board. The C port of the MAV must be connected to the valve inlet and the A port connected to the separate source used during regeneration. The B port must be connected to the feed water supply.

When set to SEPS the MAV will be driven closed before the first regeneration cycle, and be driven open after the last regeneration cycle.

NOTE: If the control valve enters into an error state during regeneration mode, the MAV will return to the open position, if not already there.

Selecting the Control Valve to act as an alternator:

519.0 and higher = Use 3-wire Interconnect Cables for all communication between units.
 518.3 and lower = Use 2-wire Interconnect Cables for twin alternators with independent flow meters.

Prior to starting the programming steps, connect the communication cable to each control valve board’s three pin connector labeled ‘COMM CABLE’. Also connect the meter cord to either control valve to the three pin connector labeled ‘METER’.			
		Softener Valve Programming Steps	
Configuration Settings	Step 5CS	Set to ALT A Connect the outlet plumbing of ALT A valve to the MAV’s A port and connect the MAV’s two pin wire connector to the two pin connector labeled “DRIVE” on the ALT A valve	Set to ALT b Connect the outlet plumbing of ALT b valve to the MAV’s B port. No electrical connections are required between the ALT b valve and the MAV.
Softener System Setup	Step 10S	Set System Capacity	Set System Capacity
Softener System Setup	Step 11S	Set to ‘AUTO’	Set to ‘AUTO’
Softener System Setup	Step 12S	Set regeneration time option to ‘on 0’.	Set regeneration time option to ‘on 0’.
Installer Display Settings	Step 3I	Set Day Override to “oFF”	Set Day Override to “oFF”

If set up for a filter, in Step 5F set Volume Capacity in Gallons; in Step 6F select Regeneration Time Option “on 0”; and in Step 3I select Day Override “oFF”.

NOTE: If the control valve is in an error state during regeneration mode the MAV will close the B port and keep open the A port until the error is corrected and reset.

WS1, WS1.25 and WS1.5 Valves

For Clack Corporation alternator systems using WS1, WS1.25 and WS1.5 valves there will be an option to delay the last two cycles of regeneration (only “Rinse” and “Fill”). This feature splits the regeneration into two portions. The first portion of the regeneration will start immediately and all programmed cycles before the “Rinse” and “Fill” cycles will be performed. After all programmed cycles before “Rinse” and “Fill” are completed the control valve will drive to the service position (displaying “Delayed Rinse + Fill Pending”). When the volume of the on-line unit is depleted to 10% of its programmed capacity, the control valve will be triggered to finish the second portion of the regeneration and complete the “Rinse” and “Fill” cycles and return to Service and be placed into Standby mode, and wait to come on-line for service. Set to oFF to deactivate this feature.

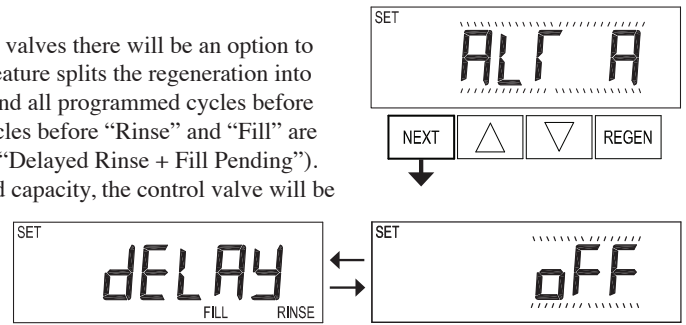

WS2 Valve

For Clack Corporation alternator systems using the WS2 valve, when NEXT is pressed after selecting ALT A or ALT B, a display will allow the user to set the amount of pre-service rinse time for the stand by tank just prior to returning to service. Set to oFF to deactivate this feature. With 1.0Γ set, the same display appears and is set in a similar manner.

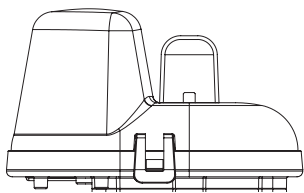
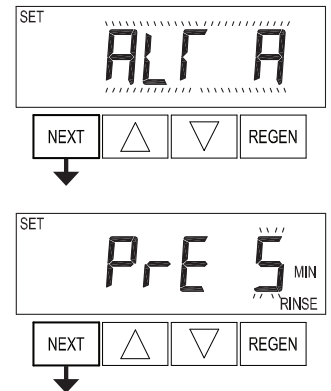

Retracted

Valve “A” in Service Position = MAV piston rod Retracted

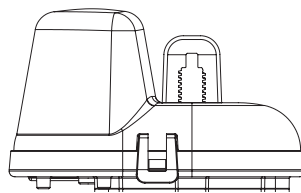

Extended

Valve “B” in Service Position = MAV piston rod Extended

Note: Clack Twin Alternator Operations

- Twin alternating systems can be programmed with a day override setting combined with the normal volume-based regeneration programming. A twin alternating system in this configuration will then regenerate based on the volume used or the day override if there is a period of low water usage.
- Twin alternating systems can be programmed as a time clock only based regenerating system. In this configuration, the days remaining are counted only on the unit that is in service. The unit in Stand-by Mode only notes days in diagnostics, which results in time clock only twin regeneration initiation.
- Twin alternating systems can be programmed for a delayed regeneration time. The system will allow an immediate transfer of the MAV to switch tanks and place a fully regenerated unit in service once a unit becomes exhausted. The exhausted unit will then be placed into Stand-by Mode and allowed to have a delayed regeneration at the pre-set time.

Configuring the Control Valve for System Controller Operation:

Select "SYS" to link control valve to System Controller. For communication between control valve and System Controller, a three-wire communication cable is required.

Selection requires that a connection to a Clack No Hard Water Bypass (V3070FF or V3070FM) be made to the two-pin connector labeled MAV located on the printed circuit board for WS1 and WS1.25 control valves. For valve types WS1.5 and WS2, a connection from a Clack No Hard Water Bypass (V3097/BSPT or V3098/BSPT) to the two pin connector labeled MAV located on the printed circuit board is required.

Press NEXT to go to Step 6CS. Press REGEN to return to previous step.

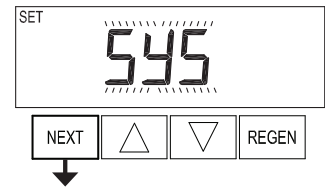

Step 6CS

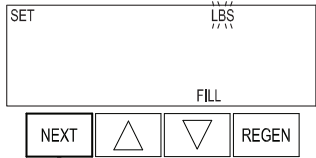

Step 6CS – Fill Units: If set as a softener, if Step 2CS is set to 1.5, and FILL is part of the Regeneration Cycle Sequence, FILL UNITS of MIN or LBS can be selected. Press NEXT to exit OEM Configuration Setup. Press REGEN to return to previous step.



EXIT TO DISPLAY SCREENS

OEM Softener System Setup

Step 1S



Step 1S - Press NEXT and ▼ simultaneously for 5 seconds and release. If screen in Step 2S does not appear, the lock on valve programming has been activated. To unlock press ▼, NEXT, ▲, REGEN in sequence, then press NEXT and ▼ simultaneously for 5 seconds and release.

Step 2S



Step 2S – Choose SOFTENING using ▲ or ▼. Press NEXT to go to Step 3S. Press REGEN to exit OEM Softener System Setup.

Step 3S



Step 3S – Choose Brining Direction using ▲ or ▼. This screen is not viewed when Step 2S is set to Filtering. Press NEXT to go to Step 4S. Press REGEN to return to previous step.

Step 4S



Step 4S – Set Refill location using ▲ or ▼:

- “PoST” to refill the brine tank after the final rinse; or
- “PrE” to refill the brine tank four hours before the regeneration time set.

This screen is not viewed when Step 2S is set to Filtering.

Press NEXT to go to Step 5S. Press REGEN to return to previous step.

Step 5S



Step 5S – Select the time for the first cycle using ▲ or ▼. For valve types 1.5 and 2.0, “oFF” is also available.

Press NEXT to go to Step 6S. Press REGEN to return to previous step.

Step 6S



Step 6S – Select the time for the second cycle using ▲ or ▼. For valve types 1.5 and 2.0, “oFF” is also available.

NOTE: The display will flash between cycle number and time, and brine direction (UP or dn).

Press NEXT to go to Step 7S. Press REGEN to return to previous step.

Step 7S



Step 7S – Select the time for the third cycle using ▲ or ▼. For valve types 1.5 and 2.0, “oFF” is also available.

Press NEXT to go to Step 8S. Press REGEN to return to previous step.

Step 8S



Step 8S – Select the time for the fourth cycle using ▲ or ▼. For valve types 1.5 and 2.0, “oFF” is also available.

Press NEXT to go to Step 9S. Press REGEN to return to previous step.

Step 9S

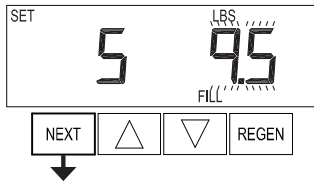

Step 9S – Select the pounds for the fifth cycle using ▲ or ▼. For valve types 1.5 and 2.0, “oFF” is also available.

NOTE: if Step 2CS is set to 2.0 or Step 7CS is set to MIN, Fill will be in minutes. Press NEXT to go to Step 10S. Press REGEN to return to previous step.

Step 10S

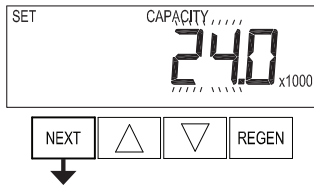

Step 10S – Set System Capacity using ▲ or ▼. The System Capacity setting should be based on the volume of resin and LBS of salt fill set in Step 9S. Press NEXT to go to Step 11S. Press REGEN to return to previous step.

Step 11S

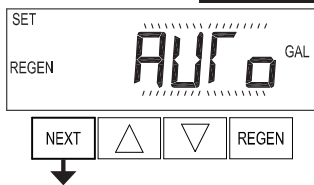

Step 11S – Set Volume Capacity using ▲ or ▼. If value is set to:

- “AUTO” capacity will be automatically calculated and reserve capacity will be automatically estimated;
- “oFF” regeneration will be triggered solely by the day override setting (see Installer Display/Settings Step 4I);
- a number, regeneration will be triggered by the value specified (in Gallons).

If “oFF” or a volume is used, the hardness display will not be allowed to be set in Installer Display Settings Step 2I. See Setting Options Table for more detail. Press NEXT to go to Step 12S. Press REGEN to return to previous step.

Step 12S

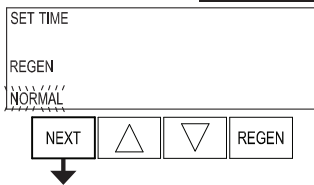

Step 12S – Set Regeneration Time Options using ▲ or ▼. If value is set to:

- “NORMAL” means regeneration will occur at the preset time;
- “on 0” means regeneration will occur immediately when the volume capacity reaches 0 (zero); or
- “NORMAL + on 0” means regeneration will occur at one of the following:
 - the preset time when the volume capacity falls below the reserve or the specified number of days between regenerations is reached whichever comes first; or
 - immediately after 10 minutes of no water usage when the volume capacity reaches 0 (zero).

“NORMAL” is the default if Step 5CS is set to ALT A or ALT B, and “NORMAL + on 0” is not available.

“on 0” is the default if Step 2CS is set to 1.0Γ, and “NORMAL + on 0” is not available.

This step will not appear if Step 11S is set to oFF or Step 5CS is set to “SYS”.

See Setting Options Table for more detail. Press NEXT to go to Step 13S. Press REGEN to return to previous step.

Step 13S

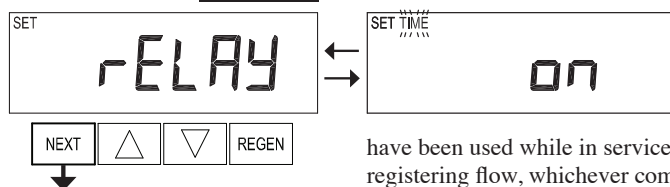

Step 13S – Set Relay Operation using ▲ or ▼. The choices are:

- Set Time on: Relay activates after a set time at the beginning of a regeneration and then deactivates after a set period of time. The start of regeneration is defined as the first backwash cycle or Dn brine cycle, whichever comes first.
 - Set Gallons Softening on: Relay activates after a set number of gallons have been used while in service and then deactivates after a set period of time or after the meter stops registering flow, whichever comes first.
 - Set Gallons Softening Regen on: Relay activates after a set number of gallons have been used while in service or during regeneration and then deactivates after a set period of time or after the meter stops registering flow, whichever comes first.
 - ERROR: Relay closes whenever the valve enters error mode, and immediately deactivates when error mode is exited. If set to ERROR, Steps 14S and 15S will not be shown.
 - Set Off: If set to Off, Steps 14S and 15S will not be shown.
- Press NEXT to go to Step 14S. Press REGEN to return to previous step.

Step 14S

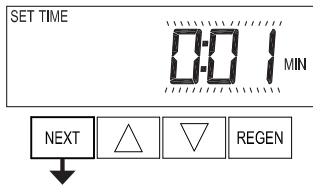

Step 14S – Set Relay Actuation Time or Gallons using ▲ or ▼. The choices are:

- Relay Actuation Time: After the start of a regeneration the amount of time that should pass prior to activating the relay. The start of regeneration is defined as the first backwash cycle, Dn brine cycle or UP brine cycle whichever comes first. Ranges from 1 second to 200 minutes.
- Relay Actuation Gallons: Relay activates after a set number of gallons has passed through the meter. Ranges from 1 to 200 gallons.

Press NEXT to go to Step 15S. Press REGEN to return to previous step.

Step 15S

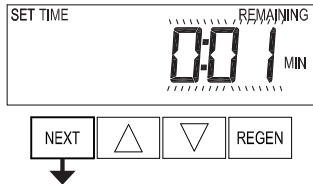

Step 15S – Set Relay Deactivate Time using ▲ or ▼.

- If Set Time on is selected in Step 13S the relay will deactivate after the time set has expired. Ranges from 1 second to 200 minutes.
- If Set Gallons Softening on or Set Gallons Softening Regen on is selected in Step 13S the relay will deactivate after the time set has expired or after the meter stops registering flow, whichever comes first. Ranges from 1 second to 20 minutes.

Press NEXT to exit OEM Softener System Setup. Press REGEN to return to previous step.

EXIT OEM SOFTENER SYSTEM SETUP

Setting Options Table

Filters should only use shaded options

Volume Capacity	Regeneration Time Option	Day Override	Result ¹
AUTO	NORMAL	oFF	Reserve capacity automatically estimated. Regeneration occurs when volume capacity falls below the reserve capacity at the next Regen Set Time.
AUTO	NORMAL	Any number	Reserve capacity automatically estimated. Regeneration occurs at the next Regen Set Time when volume capacity falls below the reserve capacity or the specified number of days between regenerations is reached.
Any number	NORMAL	oFF	Reserve capacity <u>not</u> automatically estimated. Regeneration occurs at the next Regen Set Time when volume capacity reaches 0.
oFF	NORMAL	Any number	Reserve capacity <u>not</u> automatically estimated. Regeneration occurs at the next Regen Set Time when the specified number of days between regenerations is reached.
Any number	NORMAL	Any number	Reserve capacity <u>not</u> automatically estimated. Regeneration occurs at the next Regen Set Time when volume capacity reaches 0 or the specified number of days between regenerations is reached.
AUTO	On 0	oFF	Reserve capacity <u>NOT</u> automatically estimated. Regeneration occurs immediately when volume capacity reaches 0. Time of regeneration will not be allowed to be set because regeneration will always occur when volume capacity reaches 0.
Any number	On 0	oFF	Reserve capacity <u>NOT</u> automatically estimated. Regeneration occurs immediately when volume capacity reaches 0. Time of regeneration will not be allowed to be set because regeneration will always occur when volume capacity reaches 0.
AUTO	NORMAL on 0	oFF	Reserve capacity automatically estimated. Regeneration occurs when volume capacity falls below the reserve capacity at the next Regen Set Time or regeneration occurs after 10 minutes of no water usage when volume capacity reaches 0.
AUTO	NORMAL on 0	Any number	Reserve capacity automatically estimated. Regeneration occurs at the next Regen Set Time when volume capacity falls below the reserve capacity or the specified number of days between regenerations is reached or regeneration occurs after 10 minutes of no water usage when volume capacity reaches 0.
Any number	NORMAL on 0	Any number	Reserve capacity <u>not</u> automatically estimated. Regeneration occurs at the next Regen Set Time when the specified number of days between regenerations is reached or regeneration occurs after 10 minutes of no water usage when volume capacity reaches 0.

¹ Reserve Capacity estimate is based on history of water usage. Reserve Capacity estimate is not available with alternator systems or Twin Tank Valve.

OEM Filter System Setup

Cycle Sequence, Adjustable Default Times (minutes)						
Type	Backwash	Draw	Backwash	Rinse	Backwash*	Fill
Filtering Backwash	8			4		
Filtering Regen	8	60	8	8	0:30	.95 GAL
Filtering Regen (2.0")	8	60	8	8	0:30	6

*Cycle is non-adjustable, not shown in cycle sequence programming.

Step 1F

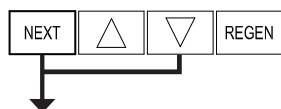

Step 1F - Press NEXT and ▼ simultaneously for 5 seconds and release. If screen in Step 2CS does not appear, the lock on the valve is activated. To unlock press ▼, NEXT, ▲, REGEN in sequence, then press NEXT and ▼ simultaneously for 5 seconds and release.

Step 2F

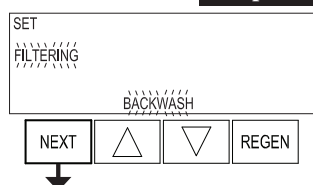

Step 2F - Choose FILTERING BACKWASH or FILTERING REGEN (see table) using ▲ or ▼. Press NEXT to go to Step 3F. Press REGEN to exit OEM Filter System Setup.



Step 3F

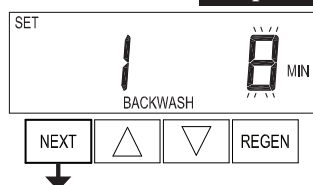

Step 3F - Select the time for the first cycle using ▲ or ▼. Press NEXT to go to Step 4F. Press REGEN to return to previous step.

Step 4F



Step 4F - Select the time for the second cycle using ▲ or ▼. If Step 2F is set to FILTERING REGEN, press NEXT to program the rest of the cycle times. If Step 2F is set to FILTERING BACKWASH, press NEXT to go to Step 5F. Press REGEN to return to previous step.

Step 5F



Step 5F - Set Regeneration trigger using ▲ or ▼. If value is set to:

- “OFF” regeneration will be triggered solely by the day override setting (see Installer Display/Settings Step 4I);
- a number, regeneration will be triggered by the value specified (in gallons). See Setting Options Table for more detail.

Press NEXT to go to Step 6F. Press REGEN to return to previous step.

Step 6F

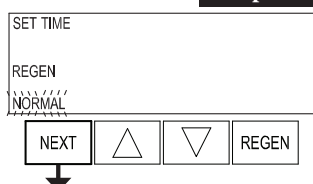

Step 6F - Set Regeneration Time Options using ▲ or ▼. If value is set to:

- “NORMAL” means regeneration will occur at the preset time;
- “on 0” means regeneration will occur immediately when the volume capacity reaches 0 (zero); or
- “NORMAL + on 0” means regeneration will occur at one of the following:
 - the preset time when the volume capacity falls below the reserve or the specified number of days between regenerations is reached whichever comes first; or
 - immediately after 10 minutes of no water usage when the volume capacity reaches 0 (zero).

“NORMAL” is the default if Step 5CS is set to ALT A or ALT B, and “NORMAL + on 0” is not available. “on 0” is the default if Step 2CS is set to 1.0Γ, and “NORMAL + on 0” is not available. This step will not appear if Step 5F is set to off or Step 5CS is set to “SYS”. See Setting Options Table for more detail. Press NEXT to go to Step 7F. Press REGEN to return to previous step.

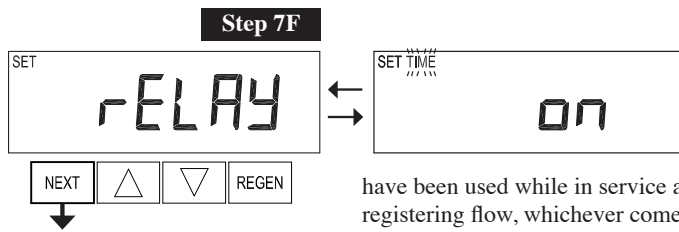

Step 7F – Set Relay Operation using ▲ or ▼. The choices are:

- Set Time on: Relay activates after a set time at the beginning of a regeneration and then deactivates after a set period of time. The start of regeneration is defined as the first backwash cycle or Dn brine cycle, whichever comes first.

- Set Gallons Filtering on: Relay activates after a set number of gallons have been used while in service and then deactivates after a set period of time or after the meter stops registering flow, whichever comes first.

have been used while in service and then deactivates after a set period of time or after the meter stops registering flow, whichever comes first.

- Set Gallons Filtering Regen on: Relay activates after a set number of gallons have been used while in service or during regeneration and then deactivates after a set period of time or after the meter stops registering flow, whichever comes first.

- ERROR: Relay closes whenever the valve enters error mode, and immediately deactivates when error mode is exited. If set to ERROR, Steps 8F and 9F will not be shown.

- Set Off: If set to Off, Steps 8F and 9F will not be shown.

Press NEXT to go to Step 8F. Press REGEN to return to previous step.

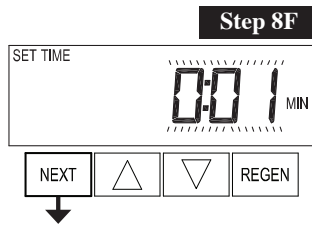

Step 8F – Set Relay Actuation Time or Gallons using ▲ or ▼. The choices are:

- Relay Actuation Time: After the start of a regeneration the amount of time that should pass prior to activating the relay. The start of regeneration is defined as the first backwash cycle or brine cycle, whichever comes first. Ranges from 1 second to 200 minutes.

- Relay Actuation Gallons: Relay activates after a set number of gallons has passed through the meter. Ranges from 1 to 200 gallons.

Press NEXT to go to Step 9F. Press REGEN to return to previous step.

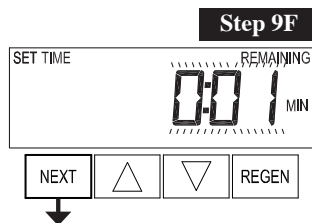

Step 9F – Set Relay Deactivate Time using ▲ or ▼.

- If Set Time on is selected in Step 7F the relay will deactivate after the time set has expired. Ranges from 1 second to 200 minutes.

- If Set Gallons Filtering on or Set Gallons Filtering Regen on is selected in Step 7F the relay will deactivate after the time set has expired or after the meter stops registering flow, whichever comes first. Ranges from 1 second to 20 minutes.

Press NEXT to exit OEM Filter System Setup. Press REGEN to return to previous step.

EXIT OEM FILTER SYSTEM SETUP

Installer Display Settings

Step 1I

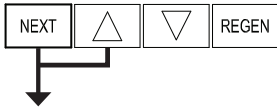

Step 1I - To enter Installer Display press NEXT and ▲ simultaneously for about 5 seconds and release.

Step 2I

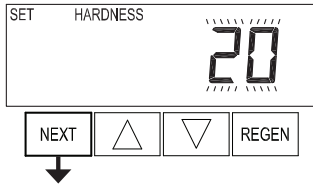

Step 2I – Hardness: Set the amount of influent hardness using ▲ or ▼. This display will not be viewed if FILTERING BACKWASH or FILTERING REGEN is selected in Step 2F or if “oFF” or a number was selected in Step 1IS.

Press NEXT to go to step 3I. Press REGEN to exit Installer Display Settings.

Step 3I

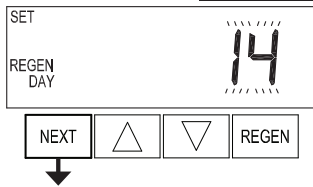

Step 3I – Day Override: When volume capacity is set to “oFF”, sets the number of days between regenerations. When volume capacity is set to AUTO or to a volume, sets the maximum number of days between regenerations. If value set to “oFF”, regeneration initiation is triggered solely by volume used. If value is set in days (allowable range from 1 to 28) regeneration initiation will be called for on that day regardless of actual water usage. Set Day Override using ▲ or ▼:

- number of days between regeneration (1 to 28); or
- “oFF”.

See Setting Options Table for more detail on setup.

Press NEXT to go to step 4I. Press REGEN to return to previous step.

Step 4I



Step 4I – Next Regeneration Time (hour): Set the hour of day for regeneration using ▲ or ▼. The default time is 2:00. This display will show “REGEN on 0 GAL” if “on 0” is selected in Set Regeneration Time Option in OEM Softener System Setup or OEM Filter System Setup.

Press NEXT to go to step 5I. Press REGEN to return to previous step.

Step 5I



Step 5I – Next Regeneration Time (minutes): Set the minutes of day for regeneration using ▲ or ▼. This display will not be shown if “on 0” is selected in Set Regeneration Time Option in OEM Softener System Setup or OEM Filter System Setup.

Press NEXT to exit Installer Display Settings. Press REGEN to return to previous step.

EXIT INSTALLER DISPLAY SETTINGS

Diagnostics

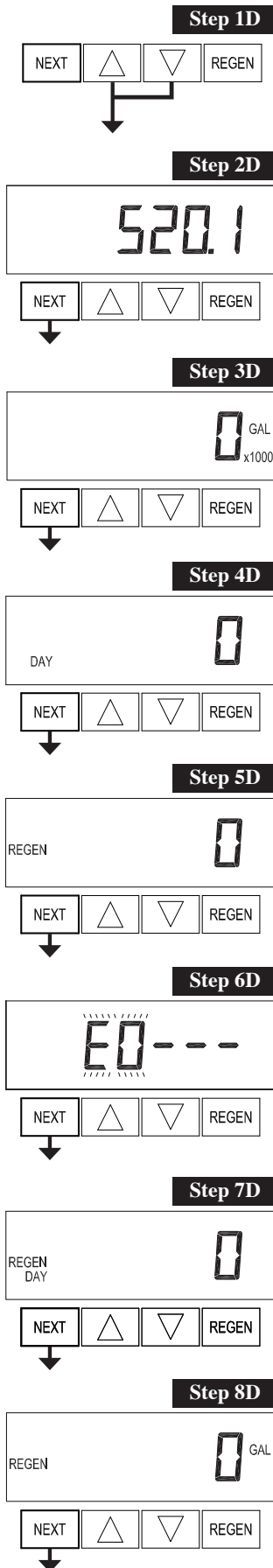

Step 1D - Press ▲ and ▼ simultaneously for 5 seconds and release. If screen in Step 2D does not appear the lock on the valve is activated. To unlock press ▼, NEXT, ▲, REGEN in sequence, then press ▲ and ▼ simultaneously for 5 seconds and release.

Step 2D – Software Version. Press NEXT to go to Step 3D. Press REGEN to exit Diagnostics.

Step 3D – Volume, total used since start-up: This display shows the total gallons treated since startup. This display will equal zero if a water meter is not installed. Press the NEXT button to go to Step 4D. Press REGEN to return to previous step.

Step 4D – Days, total since start-up: This display shows the total days since startup. Press the NEXT button to go to Step 5D. Press REGEN to return to previous step.

Step 5D – Regenerations, total number since start-up: This display shows the total number of regenerations that have occurred since startup. Press the NEXT button to go to Step 6D. Press REGEN to return to previous step.

Step 6D – Error Log: This display shows a history of the last 10 errors generated by the control during operation. Press ▲ or ▼ to view each recorded error. Press NEXT to go to Step 7D. Press REGEN to return to previous step.

Step 7D – Days, since last regeneration: This display shows the days since the last regeneration occurred. Press NEXT to go to Step 8D. Press REGEN to return to previous step.

Step 8D – Volume, since last regeneration: This display shows the volume of water that has been treated since the last regeneration. This display will equal zero when a water meter is not installed. Press NEXT to go to Step 9D. Press REGEN to return to previous step.

Step 9D

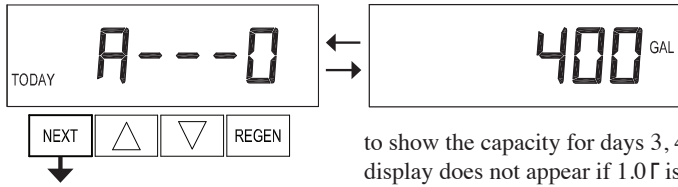

Step 9D – Volume, reserve capacity used for last 7 days: If the valve is set up as a softener, a meter is installed, and Set Volume Capacity is set to “Auto,” this display shows day 0 (for today) and flashes the reserve capacity. Pressing ▲ will show day 1 (which would be yesterday) and flashes the reserve capacity used. Pressing ▲ again will show day 2 (the day before yesterday) and the reserve capacity. Keep pressing ▲ to show the capacity for days 3, 4, 5 and 6. ▼ can be pressed to move backwards in the day series. This display does not appear if 1.0Γ is set in Step 2CS, if ALT A or ALT B are selected in Step 5CS, or anytime the reserve capacity is not determined by the control. Press NEXT at any time to go to Step 10D. Press REGEN to return to previous step.

Step 10D

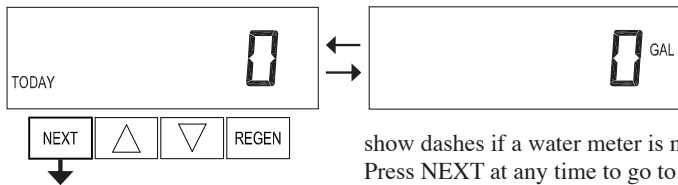

Step 10D – Volume, 63-day usage history: This display shows day 0 (for today) and flashes the volume of water treated today. Pressing ▲ will show day 1 (which would be yesterday) and flashes the volume of water treated on that day. Continue to press ▲ to show the maximum volume of water treated for the last 63 days. If a regeneration occurred on the day the word “REGEN” will also be displayed. This display will show dashes if a water meter is not installed. Press NEXT at any time to go to Step 11D. Press REGEN to return to previous step.

Step 11D

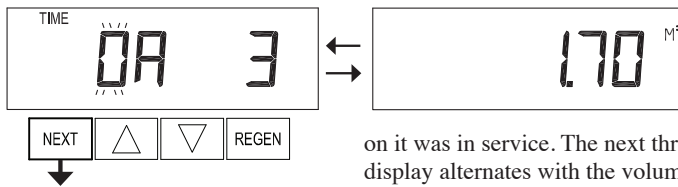

Step 11D – Twin Tank Valve transfer history: only displays when 1.0Γ was selected in Step 2CS. Use ▲ or ▼ to scroll through the last 10 tank transfers. The first position in the display ranges from 0 to 9 with the lowest number being the most recent transfer. The second position in the display will be either “A” or “b”. If “A” then the tank with the valve on it was in service, if “b” the tank with the in/out head on it was in service. The next three digits represent the number of hours ago that the transfer occurred. The display alternates with the volume that was treated before the tank transferred. Press NEXT at any time to go to Step 12D. Press REGEN to return to previous step.

Step 12D

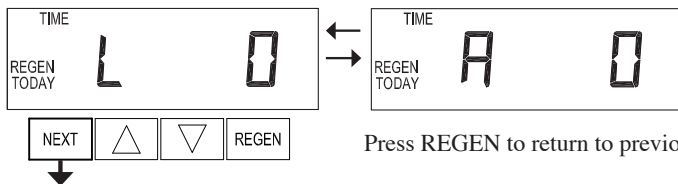

Step 12D – MAV Drive History in the direction of retracted piston rod position. Display will only be shown if 1.0Γ is selected in Step 2CS, or OFF is not selected in Step 5CS. Up to a four digit number will appear after the “L” which stands for latest and “A” which stands for average. Drive time is measured in 1/100 of a second; i.e., a 17.10 second move is displayed as “1710”. Press NEXT at any time to go to Step 13D. Press REGEN to return to previous step.

Press and hold ▲ and ▼ buttons for 3 seconds while in Step 12D to reset the MAV drive history in both the retracted and extended piston rod position. To view the old MAV drive history data for retracted and extended rod position press and hold REGEN and ▲ while in Step 12D. Press NEXT to advance display to the old MAV drive history.

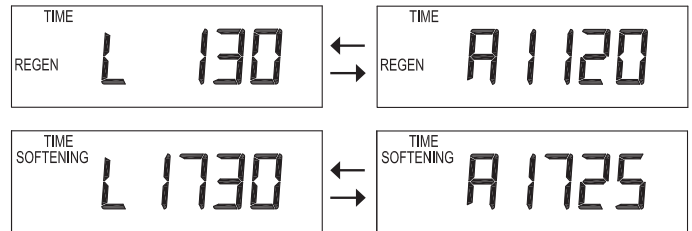

Step 13D

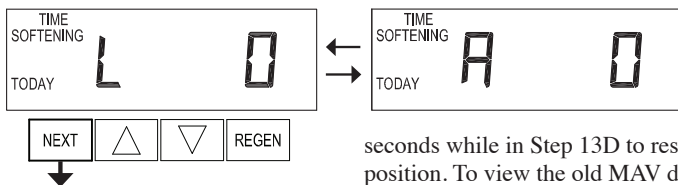

Step 13D – MAV Drive History in the direction of extended piston rod position. Display will only be shown if 1.0Γ is selected in Step 2CS, or OFF is not selected in Step 4CS. Up to a four digit number will appear after the “L” which stands for latest and “A” which stands for average. Drive time is measured in 1/100 of a second; i.e., a 17.15 second move is displayed as “1715”. Press and hold ▲ and ▼ for 3 seconds while in Step 13D to reset the MAV drive history in both the extended and retracted piston rod position. To view the old MAV drive history data see Step 12D. Press NEXT at any time exit Diagnostics. Press REGEN to return to previous step.

EXIT DIAGNOSTICS

Revision History:

12/7/2012

PAGE 5:

Added - “Used with valve type 1.0Γ,...”

1/14/2014

NOTE: All screen displays have been changed due to the larger LCD display

PAGE 4:

V3175EE-01 WS1EE FRONT COVER ASSEMBLY
V3408EE-04BOARD WS1THRU2 EE PCB 5 DIGIT REPL
-new board and cover drawings
-added relay information

PAGE 5:

Regeneration cycle times have been updated

PAGE 7:

Programming steps have all been updated to reflect the enhancements
Added Step 3CS.

PAGE 10:

Added Step 6CS

PAGE 11:

Added Softener System Setup

PAGE 12:

Step 13S – Relay Operation setup

PAGE 14:

Added Setting Options Table

PAGE 15:

Added OEM Filter System Setup

PAGE 16:

Step 7F – Relay Operation setup

PAGE 17:

New Installer Display Settings

PAGE 18:

New Diagnostics Settings – added Software Version, Volume Since Last Regeneration, Reserve Capacity, 63-day Usage History, Twin Tank Transfer History, and MAV Drive History